

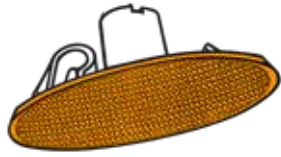

P 4660

GOL: PUNTO I (1993 → 1999)



P 4661

GOL: PUNTO I (1993 → 1999)

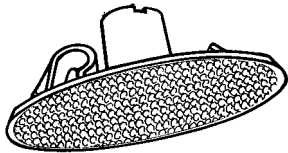

Versione speciale bianca
White special version

P 4662

GOL: PUNTO I (1993 → 1999)

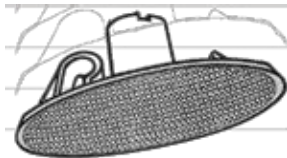

Versione speciale fumè
Smoked special version

P 4671

GOL: PUNTO I (1993 → 1999)

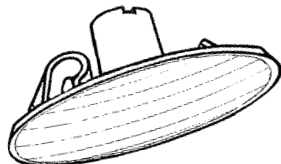

Versione speciale bianca
CRYSTAL-CLEAR
White special version

P 4672

GOL: PUNTO I (1993 → 1999)

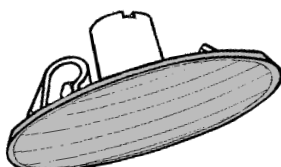

Versione speciale fumè
CRYSTAL-CLEAR
Smoked special version

P 6585

GOL: 500 (2007 →)

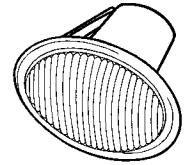

P 6586

GOL: 500 (2007 →)

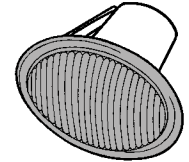

Versione speciale fumè
Smoked special version

P 4681

GOL: PUNTO II (1999 →)
DOBLO' (→ 2005)



Completo di lampada arancio WY5W
WY5W orange bulb included

P 4682

GOL: PUNTO II (1999 →)
DOBLO' (→ 2005)



Versione speciale fumè
Smoked special version

P 4691

GOL: PUNTO II (1999 →)
DOBLO' (→ 2005)

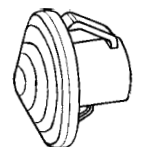

Versione speciale bianca
CRYSTAL-CLEAR
White special version

P 4692

GOL: PUNTO II (1999 →)
DOBLO' (→ 2005)

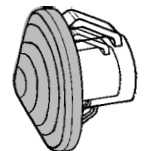

Versione speciale fumè
CRYSTAL-CLEAR
Smoked special version

P 4696

GOL: PUNTO II (1999 →)
DOBLO' (→ 2005)

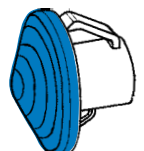

Versione speciale blu
CRYSTAL-CLEAR
Blue special version



P 4651

PFL: SEICENTO (1998 →)
MULTIPLA (1999 →)

MTA: CARELLO



P 4652

PFL: SEICENTO (1998 →)
MULTIPLA (1999 →)

MTA: CARELLO



Versione speciale bianca
White special version

P 4653

PFL: SEICENTO (1998 →)
MULTIPLA (1999 →)

MTA: CARELLO



Versione speciale fumè
Smoked special version

P 142 /D /S

GOL: Tipo (2015 →)



P 143 /D /S

GOL: Tipo (2015 →)

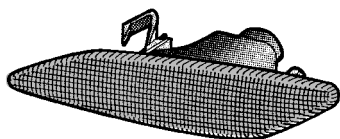

Versione speciale fumè
Smoked special version

P 4790

GOL: STILO - IDEA - PANDA (2003 →)
MULTIPLA (2004 →)
DOBLO' (2005 →)
GRANDE PUNTO (2005 →)
FIORINO (2008 →)

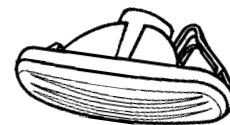

P 4791

GOL: STILO - IDEA - PANDA (2003 →)
MULTIPLA (2004 →)
DOBLO' (2005 →)
GRANDE PUNTO (2005 →)
FIORINO (2008 →)

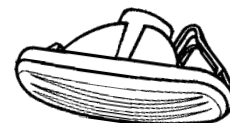

Corpo metallizzato
Chromium plated body

P 4792

GOL: STILO - IDEA - PANDA (2003 →)
MULTIPLA (2004 →)
DOBLO' (2005 →)
GRANDE PUNTO (2005 →)
FIORINO (2008 →)



Versione speciale fumè
Smoked special version

P 4796

GOL: STILO - IDEA - PANDA (2003 →)
MULTIPLA (2004 →)
DOBLO' (2005 →)
GRANDE PUNTO (2005 →)
FIORINO (2008 →)



Versione speciale blu
Blue special version

P 144 /D /S

GOL: Tipo (2015 →)



Versione speciale bianca
CRYSTAL-CLEAR
White special version

P 145 /D /S

GOL: Tipo (2015 →)

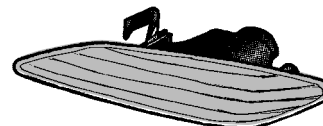

Versione speciale fumè
CRYSTAL-CLEAR
Smoked special version



P 743

FLC: Barchetta/Coupè (1994 →)

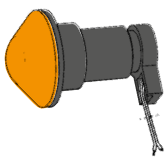

P 744

FLC: Barchetta/Coupè (1994 →)



Versione speciale bianca
White special version

P 745

FLC: Barchetta/Coupè (1994 →)

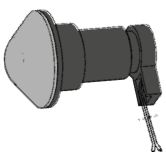

Versione speciale fumè
Smoked special version

P 8974

GOL: RITMO II Serie
UNO (→ 1989)
REGATA



P 4427

GOL: CROMA (1993 →)



P 333

GOL: DUCATO (→ 1994)



P 343

GOL: DUCATO (2000 →2006)

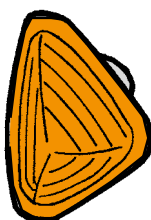

P 255



Fregio metallizzato
Mascherina 500 (2007 →)

P 259 /D
/S

Supporto metallizzato
Mascherina 500 (2007 →)



P 335 /D
/S

PFA: DUCATO (→ 1994)

MTA: SIEM

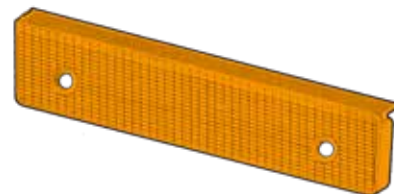



P 380 /D
/S

GOL: IVECO DAILY (2006 → 2014)

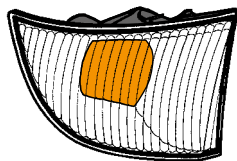

P 353 /D
/S

GOL: FIAT DUCATO (2006 →)

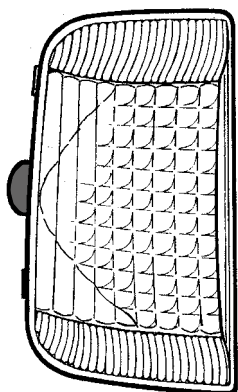

P 6171 /D
/S

PFA: IVECO DAILY (1989 → 96)

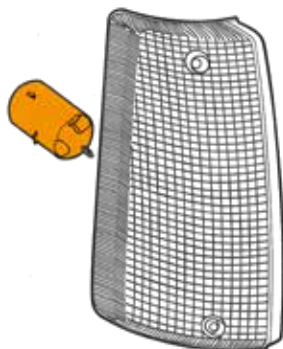

P 381 /D
/S

GOL: IVECO DAILY (2006 → 2014)

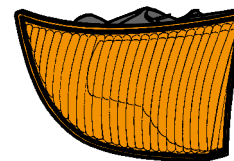

Versione speciale arancio
Orange special version

P 355 /D
/S

GOL: FIAT DUCATO (2006 →)

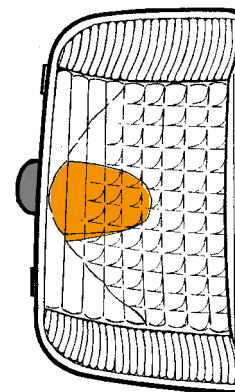

P 363 /D
/S

GOL: DOBLO' (2010 →)

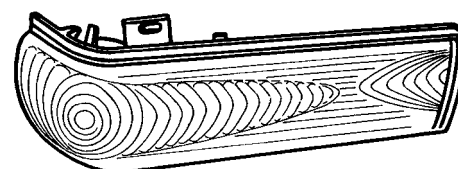



P 4655 /D
/S

GOA: MULTIPLA (1999 → 2004)

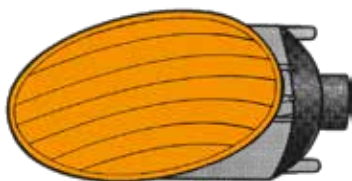

P 4656 /D
/S

GOA: MULTIPLA (1999 → 2004)

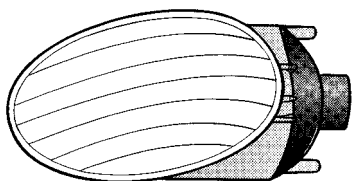

Versione speciale bianca
White special version

P 4657 /D
/S

GOA: MULTIPLA (1999 → 2004)

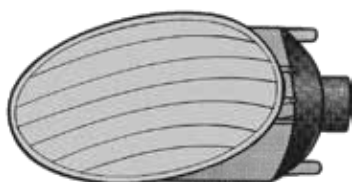

Versione speciale fumè
Smoked special version

P 8987 /D
/S

GOA: TIPO (1988 → 93)

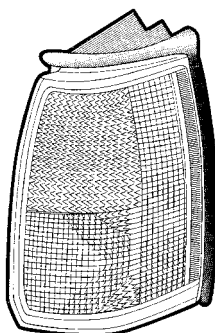

P 8988 /D
/S

P 8984 /D
/S

GOA: UNO (1990 →)

MTA: SIEM

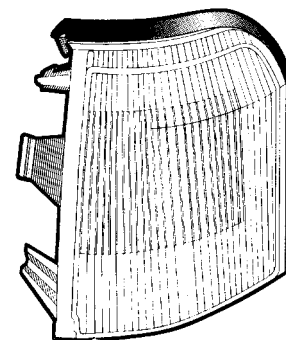

P 8985 /D
/S

P 8970 /D
/S

PFA: UNO (→ 1989)

MTA: ALTISSIMO

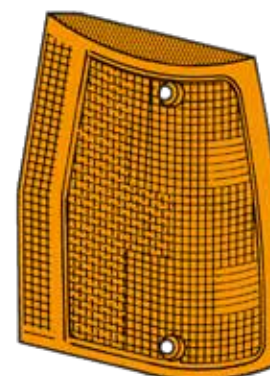
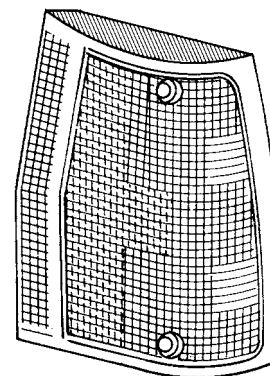

P 8971 /D
/S



P 21394

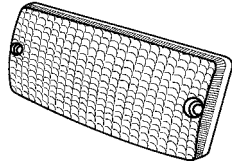

PFA: 850 Sport Spider USA

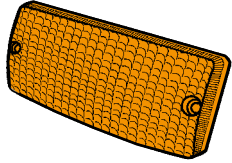

P 21395

P 11630

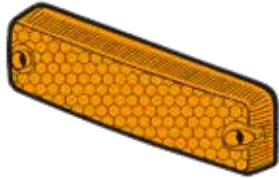

PFA: 850 Spider

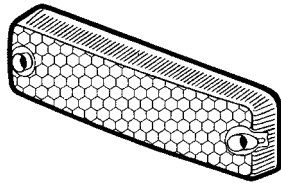

P 11631

P 714 /D /S

PFA: X 1/9 1300

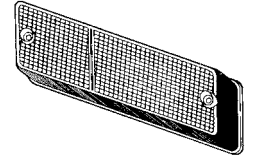

P 715 /D /S

PFA: X 1/9 1300



P 7127 /D /S

PFP: X 1/9

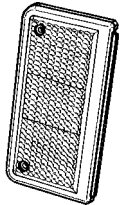

P 7124 /D /S

PFP: X 1/9

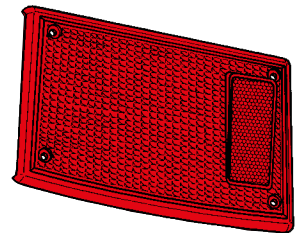

P 7126 /D /S

PFP: X 1/9

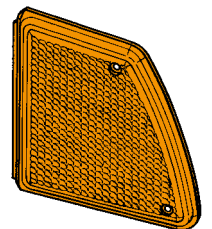

P 7125 /D /S

Versione USA
US Version

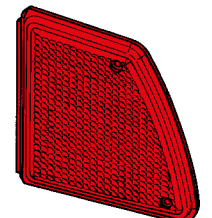



P 5339 /D
/S

PFA: 612 N2

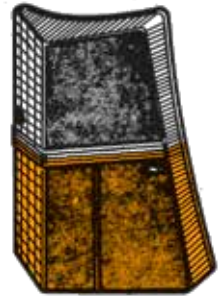

P 1807

Arancio - Orange

PFA: 238

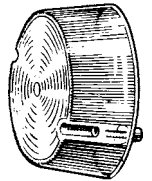

P 1806

Bianco - White

P 217

Arancio - Orange

PFA: AUTOCARRI 625 - 645
650 - 662 - 682 - 683

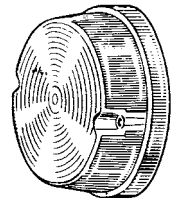

P 219

Bianco - White

P 237 /D
/S

PFA: AUTOCARRI 619 N
619T - 684N - 684T
693 - 697



P 5255 /D
/S

PFA: AUTOCARRI

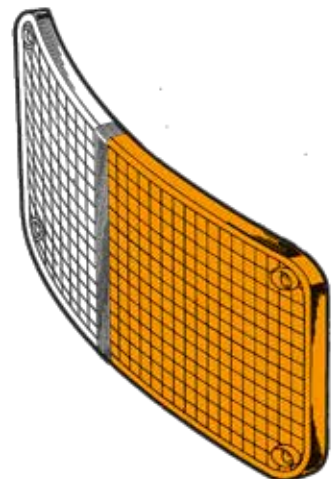



P 115

Bianco - White

P 113

Arancio - Orange

P 114

Rosso - Red

PFA: N 500 - 600 - 750 - 1100

P 117

Bianco - White

P 116

Arancio - Orange

PFA: N 500 F - N 500 L

P 118

Bianco - White

P 119

Arancio - Orange

PFA: N 500 R

P 5037 /D /S

PFA: 126 - 126 BIS

P 5036 /D /S

P 5039 /D /S

Versione speciale fumè
Smoked special version

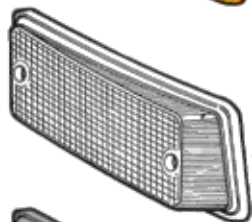
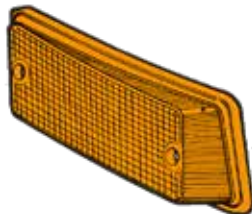
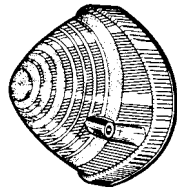
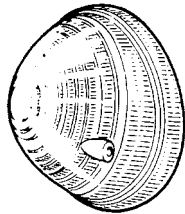
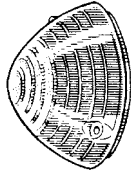

P 8821 /D /S

PFA: 127 PANORAMA
FIORINO (→ 1988)

MTA: ARTEB

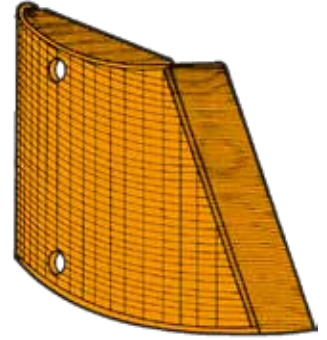

P 8973 /D /S

PFA: RITMO II Serie
(1983 →)

MTA: OLSA

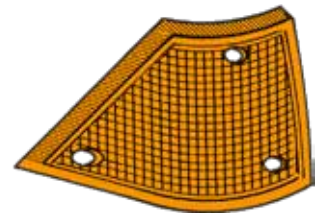

P 8972 /D /S

PFA: PANDA I Serie (→ 1985)

MTA: ELMA

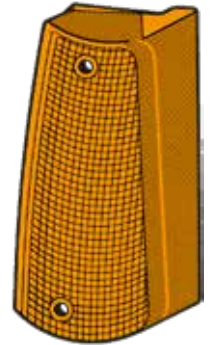

P 8975 /D /S

PFA: PANDA SUPERNOVA (1986 →)

MTA: SIEM

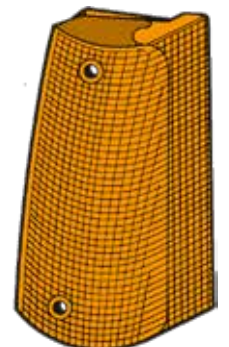
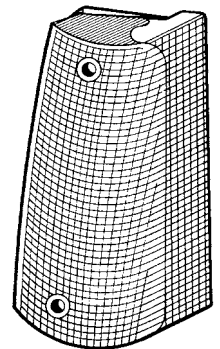

P 8976 /D /S



P 8244

Arancio - Orange

PFA: 124 BN - BREAK
LADA NIVA (→ 1981)



P 8245

Bianco - White

P 8267

PFA: 124 Special (1968)



P 5262 /D
/S

PFA: 124 Special (1971)



P 8154 /D
/S

PFA: 132

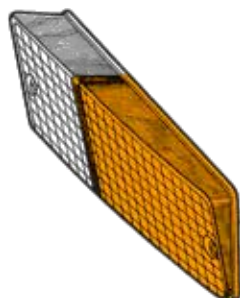

P 8823 /D
/S

PFA: 127 D (→ 1983)

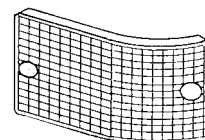

P 8824 /D
/S

P 8826 /D
/S

PFA: 127 (→ 1977)

P 8825 /D
/S

Bianco - White

P 8931 /D
/S

Tipo largo

P 8934 /D
/S

Tipo stretto

PFA: 128 (1972 → 1977)

P 8935 /D
/S

Tipo largo

P 8933 /D
/S

Tipo stretto

P 8965 /D
/S

PFA: 128 Coupè

P 8959 /D
/S

PFA: 131 (→ 1982)

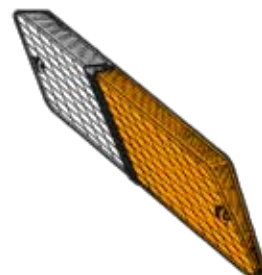
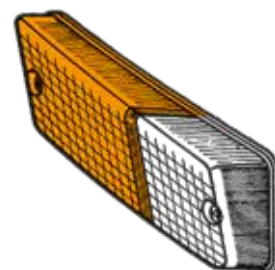
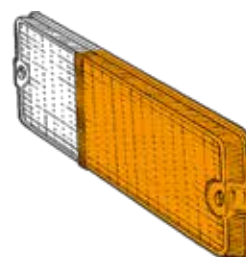
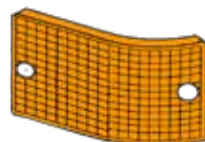



P 1752 /D
/S

PFA: 850



P 1750 /D
/S

PFA:

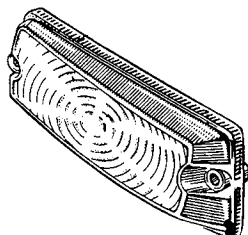

P 1757

PFA: 1100 R
850 Coupè
124 Coupè



P 1755

PFA: 1100 R
850 Coupè
124 Coupè

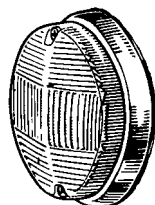

Bordo metallizzato
Chromium plated rim

P 8316

PFA: 1500 C



P 8714 /D
/S

PFA: 125 BN
125 Special



P 1766

PFA: 850 Coupè
124 Sport Coupè (1970)



P 224

PFL: AUTOCARRI 690 - 693
697 TN - 619 - 684



P 215

PFL: AUTOCARRI



P 218

PFL: AUTOCARRI 643 E - 643 NT
645 - 650 - 682



P 512

PFA: 1100 D
1300 - 1500



P 8263

PFP: 124 SPECIAL
Applicazioni varie

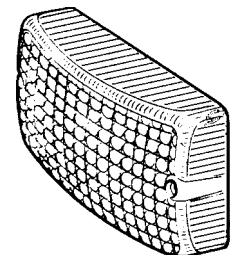

P 8264



P 155



Fregio metallizzato
Mascherina N 500

P 159

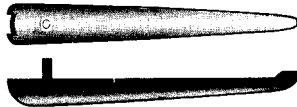

Supporto metallizzato
Mascherina N 500 - N 500F

P 156



Fregio metallizzato
Mascherina 600

P 157

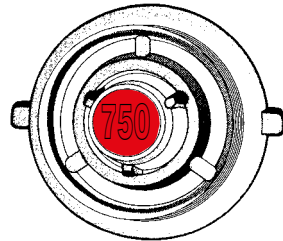

Fregio metallizzato
Mascherina 600D

P 51 /D
/S

PPF: N 500 GIARDINIERA



P 50 /D
/S

PPF: N 500 - 600D - 600E - 750

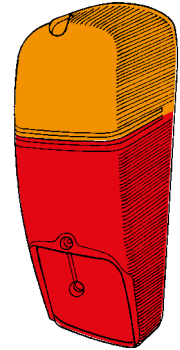

senza catadioptr
without reflex-reflector

P 55 /D
/S

PPF: N 500 - 600D - 600E - 750

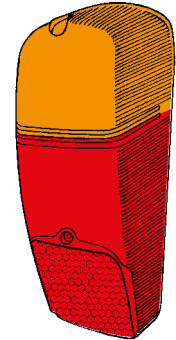

P 53 /D
/S

PPF: 500 I Serie



P 52 /D
/S

PPF: 600 II Serie





P 5075 /D
/S

FPC: 500D (1960 → 65)

MTA: Altissimo

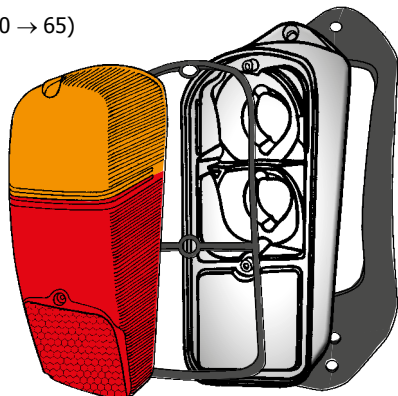

Corpo in plastica cromato
Chromed plastic body

P 5073 /D
/S

CFP: 500D (1960 → 65)

MTA: Altissimo

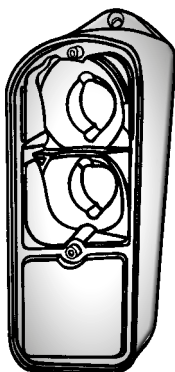

Corpo in plastica cromato
Chromed plastic body

P 5074

GFP: 500D (1960 → 65)

MTA: Altissimo

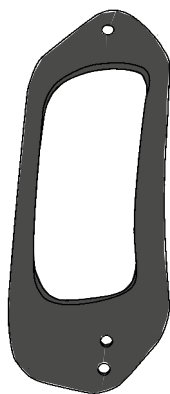

P 25

CAT: 500D - 600D - 600E - 750

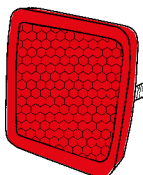

P 5065 /D
/S

FPC: 600D - 600E - 750

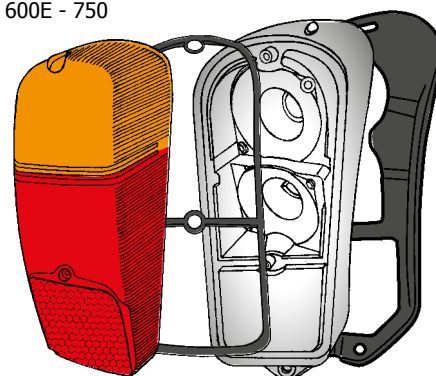

Corpo in plastica cromato
Chromed plastic body

P 5063 /D
/S

CFP: 600D - 600E - 750

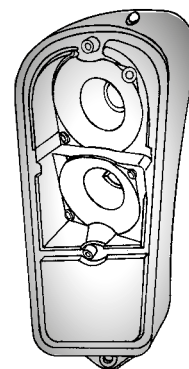

Corpo in plastica cromato
Chromed plastic body

P 5064 /D
/S

GFP: 600D - 600E - 750

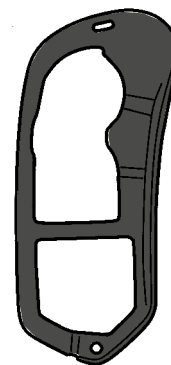

P 5076

GFP: 500D - 600D - 600E - 750

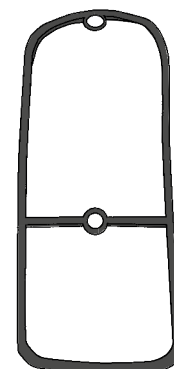



P 7910 /D
/S

PPF: N 500F - L - R
MTA: ALTISSIMO

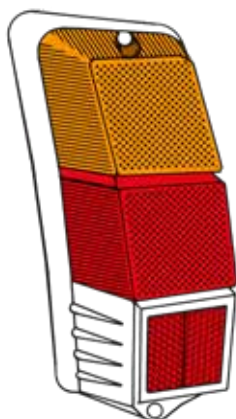

P 7911 /D
/S

PPF: N 500F - L - R
MTA: STARS

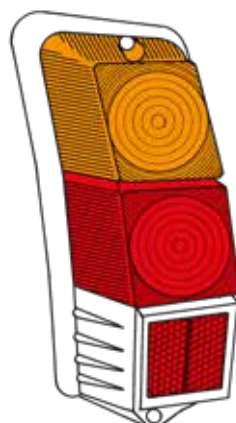

P 7934 /D
/S

GFP: N 500F - L - R

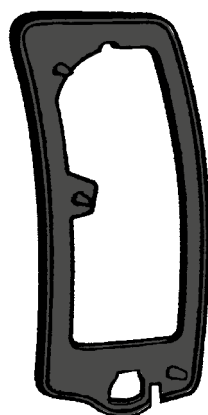

P 7931 /D
/S

CFP: N 500F - L - R

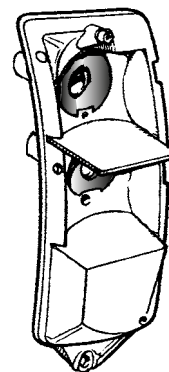

Corpo bianco con portalampane
White body with bulbholders

P 7932 /D
/S

CFP: N 500F - L - R

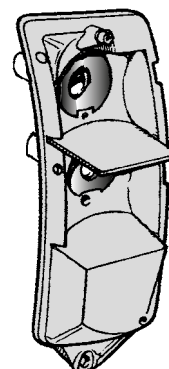

Corpo grigio con portalampane
Grey body with bulbholders

P 7933 /D
/S

CFP: N 500F - L - R

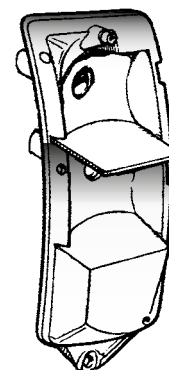

Corpo cromato con portalampane
Chromed body with bulbholders



P 7940 /D
/S

FPC: N 500F - L - R
MTA: ALTISSIMO

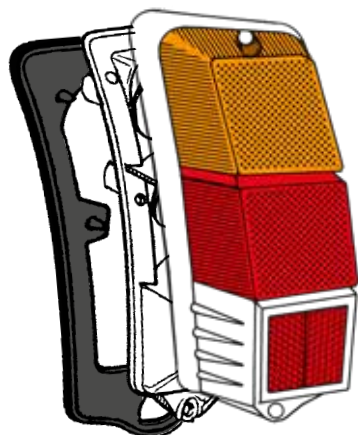

Fanale completo con corpo bianco
White body complete lamp

P 7941 /D
/S

FPC: N 500F - L - R
MTA: ALTISSIMO

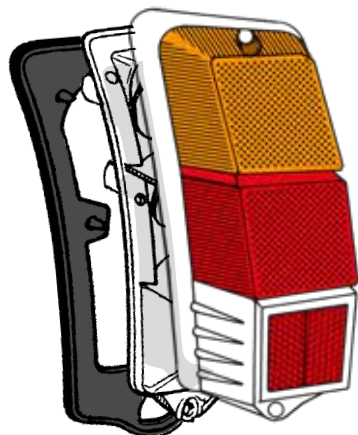

Fanale completo con corpo grigio
Grey body complete lamp

P 7942 /D
/S

FPC: N 500F - L - R
MTA: ALTISSIMO

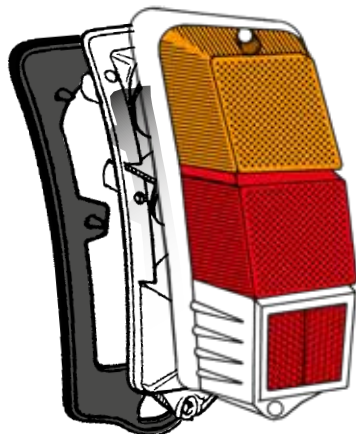

Fanale completo con corpo cromato
Chromed body complete lamp

P 7943 /D
/S

FPC: N 500F - L - R
MTA: STARS

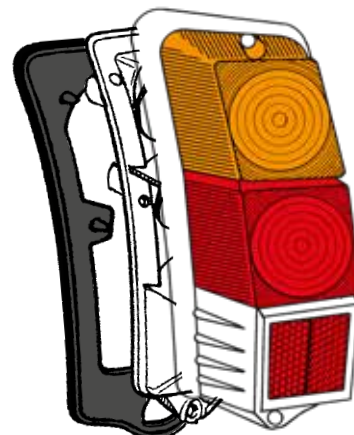

Fanale completo con corpo bianco
White body complete lamp

P 7944 /D
/S

FPC: N 500F - L - R
MTA: STARS

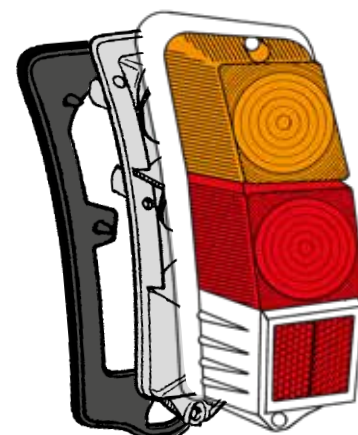

Fanale completo con corpo grigio
Grey body complete lamp

P 7945 /D
/S

FPC: N 500F - L - R
MTA: STARS

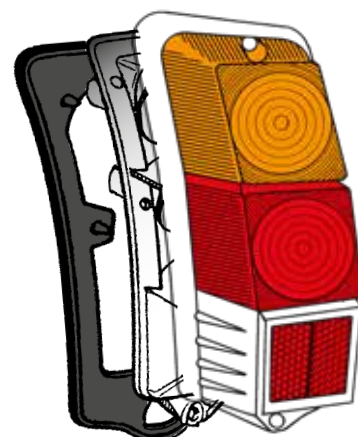

Fanale completo con corpo cromato
Chromed body complete lamp



P 5020 /D
/S

PF: 126 BLACK - BROWN
SILVER

MTA: ALTISSIMO

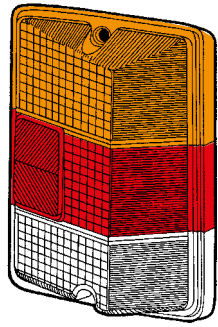

P 50201 /D
/S

PF: 126 BLACK - BROWN
SILVER

MTA: ALTISSIMO

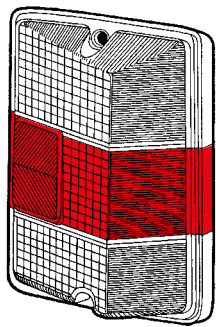

Versione speciale bianca/rossa
White/red special version

P 50202 /D
/S

PF: 126 BLACK - BROWN
SILVER

MTA: ALTISSIMO

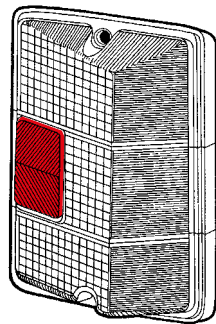

Versione speciale bianca
White special version

P 50203 /D
/S

PF: 126 BLACK - BROWN
SILVER

MTA: ALTISSIMO

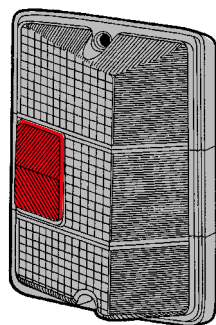

Versione speciale fumè
Smoked special version

P 5019 /D
/S

PF: 126 BIS

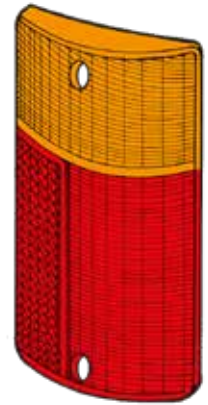

P 50191 /D
/S

PF: 126 BIS

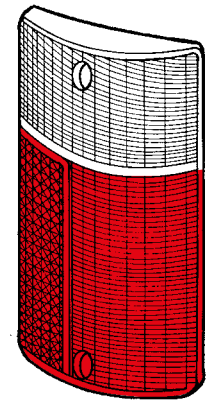

Versione speciale bianca/rossa
White/red special version

P 50192 /D
/S

PF: 126 BIS

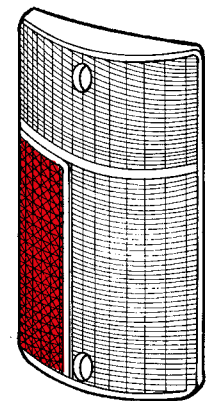

Versione speciale bianca
White special version

P 50193 /D
/S

PF: 126 BIS

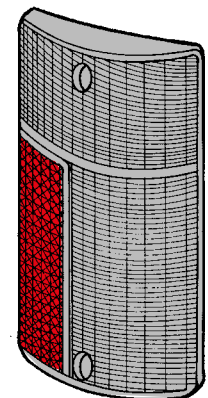

Versione speciale fumè
Smoked special version



P 5018 /D
/S

PPF: 126 - 127 FIORINO (→ 1987)

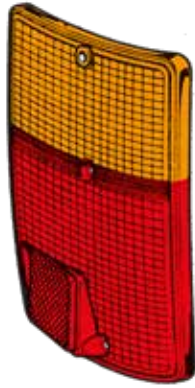

P 50181 /D
/S

PPF: 126 - 127 FIORINO (→ 1987)

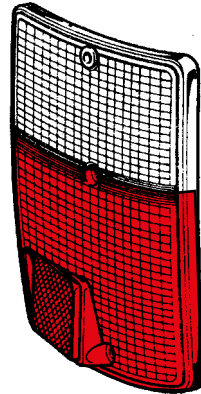

Versione speciale bianca/rossa
White/red special version

P 50182 /D
/S

PPF: 126 - 127 FIORINO (→ 1987)

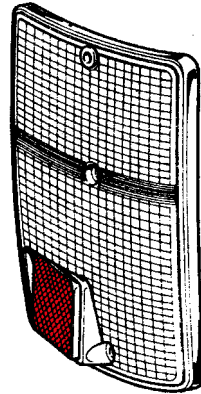

Versione speciale bianca
White special version

P 50183 /D
/S

PPF: 126 - 127 FIORINO (→ 1987)

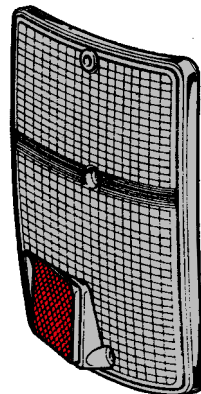

Versione speciale fumè
Smoked special version

P 5118 /D
/S

CFP: 126 - 127 FIORINO (→ 1987)

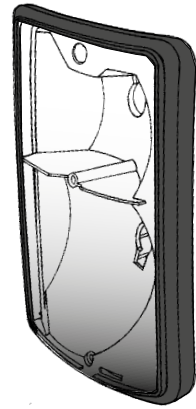

P 5120 /D
/S

CFP: 126 BLACK - BROWN
SILVER

MTA: ALTISSIMO



P 5016

PPF: 126 BIS

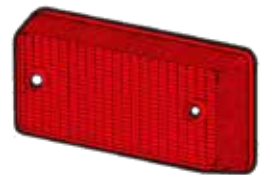

P 5017

PPF: 126 BIS

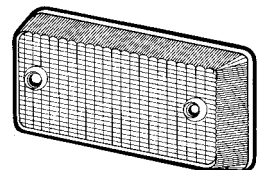



P 8995

PFP: 131 Familiare

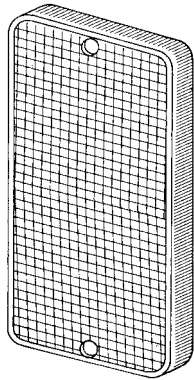

P 8996

PFP: 131 Familiare



P 8998 /D
/S

PFP: 131 Familiare

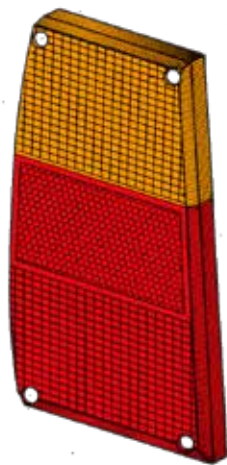

P 8938 /D
/S

PFP: 128

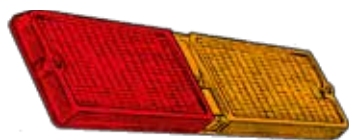

P 411

PFP: 1800 - 1500 LUNGA



P 8628

PFP: 124 Familiare



P 8248

PFP: 124
LADA NIVA (→ 1981)

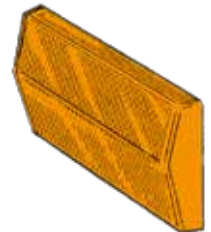

P 8249

PFP: 124
LADA NIVA (→ 1981)



P 8266 /D
/S

PFP: 124 SPECIAL

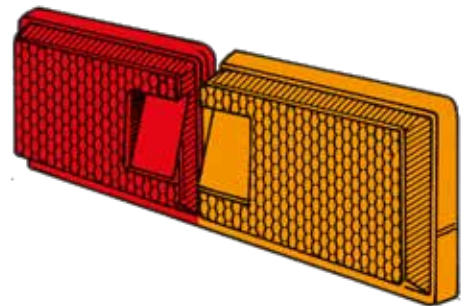

P 5003 /D
/S

PFP: 124 (1971)

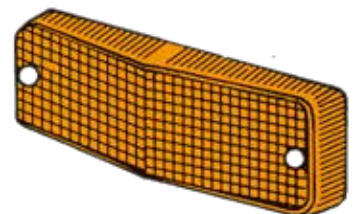

P 5005 /D
/S

PFP: 124 (1971)

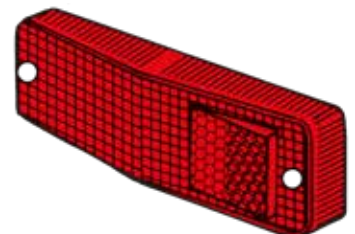



P 1758

PF: 850 - 850 COUPE'
1100 R



Cornice Inox
Inox rim

P 1759

PF: 850 COUPE'
128 RALLY



P 1700

GOP: 850 - 850 COUPE'



P 8978 /D /S

PF: UNO (→ 1989)

MTA: SIEM

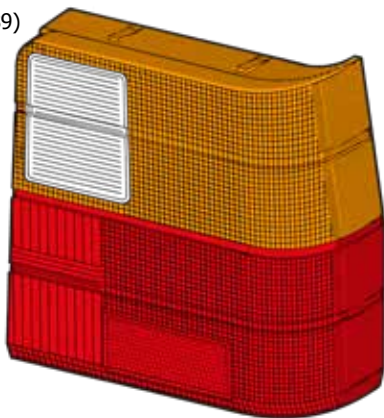

P 530

PF: 1300 - 1500

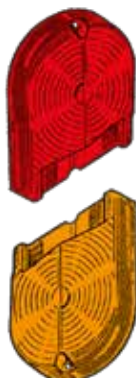

P 531

P 1756

FPC: 850 - 850 COUPE'
1100 R



Cornice Inox
Inox rim

P 1760

PF: 850 COUPE'
128 RALLY



P 8718

PF: 125 BN - SPECIAL



P 8719

PF: 125 BN - SPECIAL



P 535

PF: 1300 - 1500

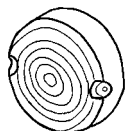

P 536



P 537





P 1805

PF: 238 - 241 TN



P 58

PF: 600 T - 850 BREAK
1100 - 103 H D
850 - 1100 FURGONE



P 59

P 2154

PF: AUTOCARRI

MTA: COBO



P 2157 /D
/S

PF: RIMORCHI

MTA: COBO



P 521

PF: AUTOCARRI
615 - 625 N - OM

MTA: COBO

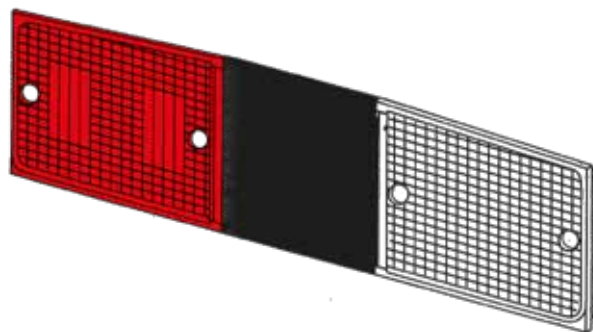

P 8599

PF: 127 FIORINO

P 63

PF: 850T - 900T - 900E



P 64

P 2155

PF: AUTOCARRI

MTA: COBO



P 2158 /D
/S

PF: RIMORCHI

MTA: COBO



P 520

PF: AUTOCARRI
615 - 625 N - OM

MTA: COBO





P 5278 /D
/S

PFP: IVECO GAMMA DAILY I
MTA: COBO

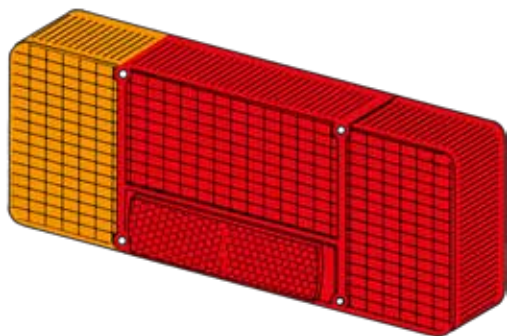

P 2144

PFP: AUTOCARRI
LUPETTO 25
LEONCINO 35

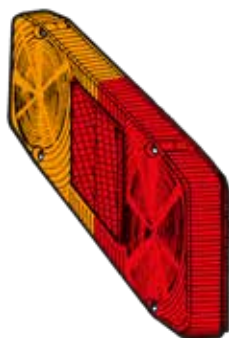

P 2140

Rosso - Red

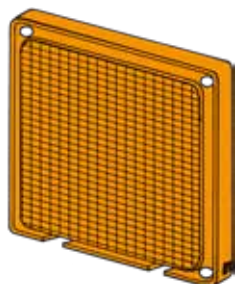

P 2141

Arancio - Orange

P 2142

Bianco - White

PFP: VARI TIPI

P 501

PFP: VARI TIPI



P 500

P 5215

PFP: 612 N2 - 625 - 645 - 650 NI
662 NI - 684 N - T/697 N



P 5105

PFP: AUTOCARRI 643 N
645 N - 683 N - 619 N

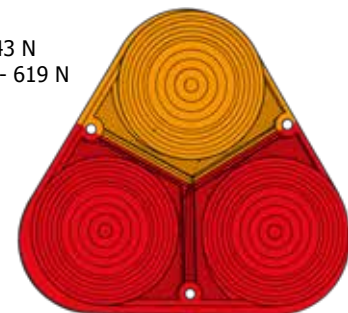

P 8827 /D
/S

PFP: 127 PANORAMA DIESEL



P 8318

PFP: 1500 C





P 8950 /D
/S

PFP: 131

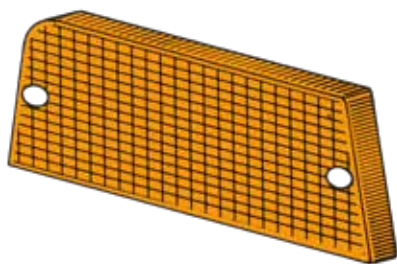

P 8951 /D
/S

PFP: 131

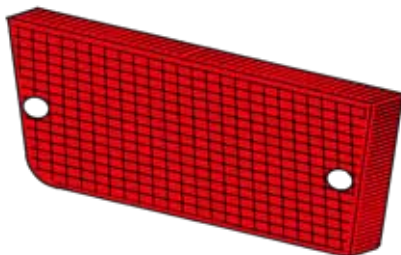

P 8952 /D
/S

PFP: 131

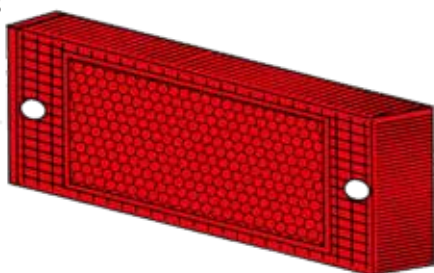

P 8953 /D
/S

PFP: 131

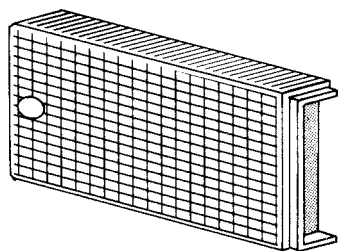

P 8828 /D
/S

PFP: 127 (→ 1977)



Fori larghi e/o stretti

P 8829 /D
/S

PFP: 127 (→ 1977)

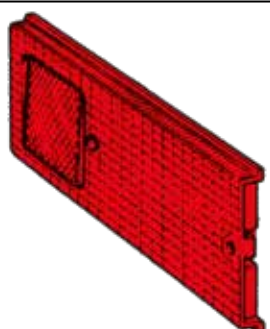

Fori larghi e/o stretti

P 9150 /D
/S

PFP: 128 SPORT
128 COUPE' S
128 COUPE' SL

MTA: ELMA

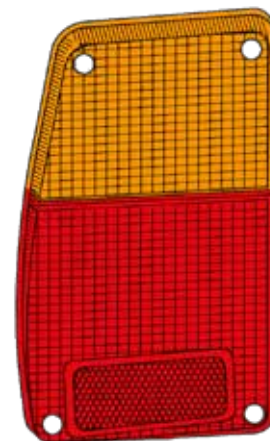

P 8947 /D
/S

PFP: 128 FAMILIARE

MTA: ALTISSIMO

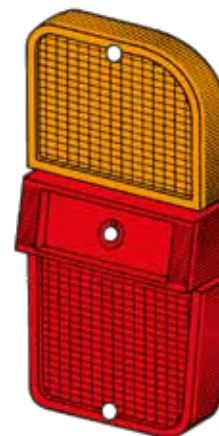

P 2203

CAT: 128 Familiare



mm 75 x 34

P 12633 /D
/S

PFP: 850 Spider
LAMBORGHINI Miura

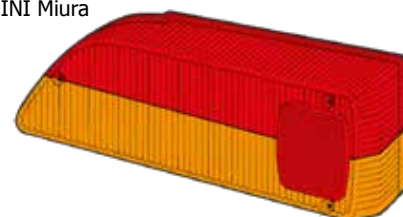

P 12635 /D
/S

PFP: 850 Spider
LAMBORGHINI Miura

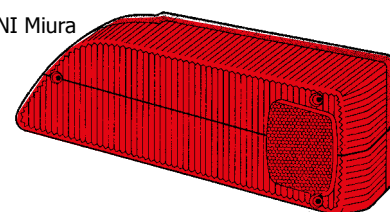

Versione USA
US Version



P 716 /D /S

PFA: 124 Spider

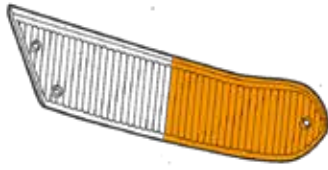

P 717 /D /S

PFA: 124 Spider

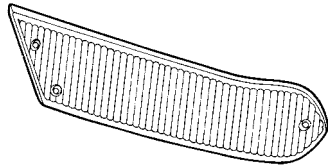

P 713 /D /S

PFP: 124 Spider 1400

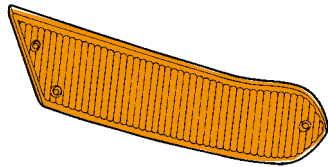

Versione USA
US Version

P 718 /D /S

PFP: 124 Spider 1400



P 719

PFP: 124 Spider 1400

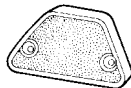

P 7134

GFP: 124 Spider II Serie



P 7135

GFP: 124 Spider II Serie



P 7117 /D /S

PFP: 124 Spider II Serie

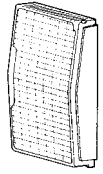

P 7114 /D /S

PFP: 124 Spider II Serie

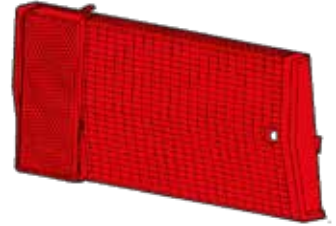

P 7116 /D /S

PFP: 124 Spider II Serie

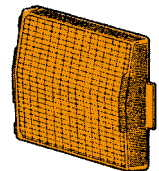

P 7115 /D /S

Versione USA
US Version

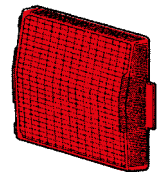

P 7118 /D /S

FPC: 124 Spider II Serie

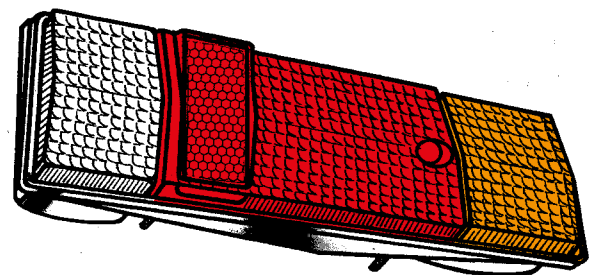

P 7119 /D /S

FPC: 124 Spider II Serie

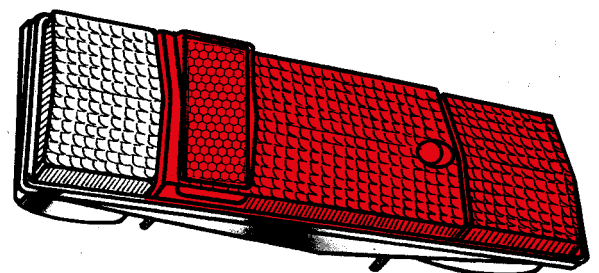

Versione USA
US Version



P 8960 /D
/S

GOA: NUOVA SEICENTO (1998 → 2000)

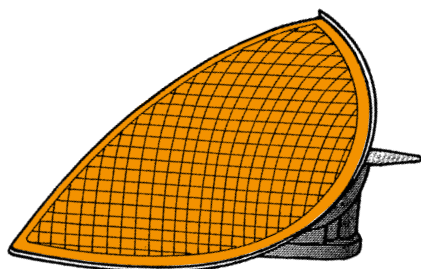

P 8961 /D
/S

GOA: NUOVA SEICENTO (1998 → 2000)

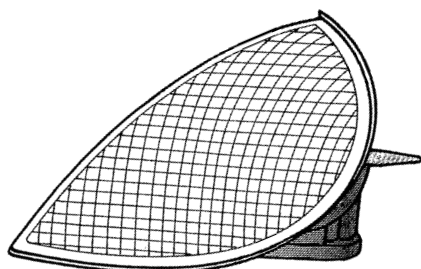

Versione speciale bianca
White special version

P 8962 /D
/S

GOA: NUOVA SEICENTO (1998 → 2000)

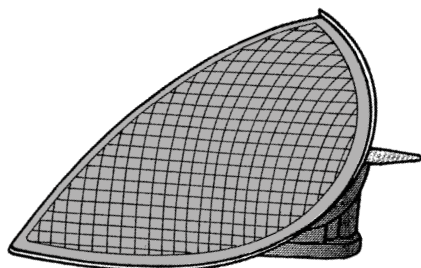

Versione speciale fumè
Smoked special version

P 8871 /D
/S

GOA: NUOVA SEICENTO (1998 → 2000)

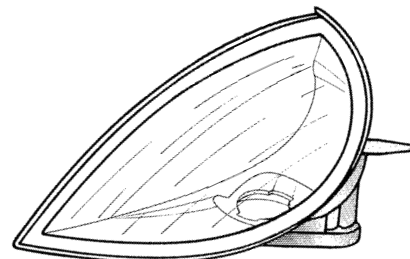

Versione speciale bianca
CRYSTAL-CLEAR
White special version

P 8872 /D
/S

GOA: NUOVA SEICENTO (1998 → 2000)

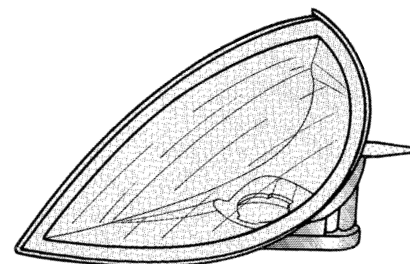

Versione speciale fumè
CRYSTAL-CLEAR
Smoked special version

FIAT



FIAT

P 8967 /D
/S

GOA: NUOVA SEICENTO (2000 →)

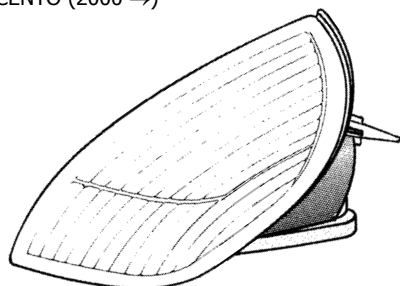

P 8968 /D
/S

GOA: NUOVA SEICENTO (2000 →)

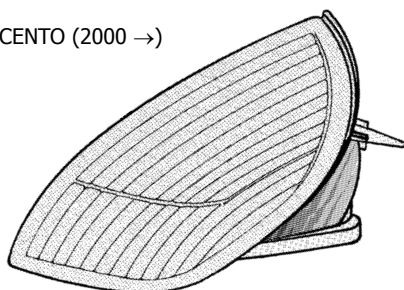

Versione speciale fumè
Smoked special version

P 8877 /D
/S

GOA: NUOVA SEICENTO (2000 →)

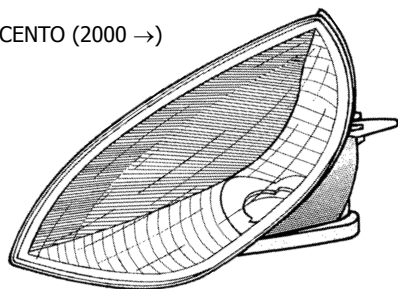

Versione speciale bianca
CRYSTAL-CLEAR
White special version

P 8878 /D
/S

GOA: NUOVA SEICENTO (2000 →)

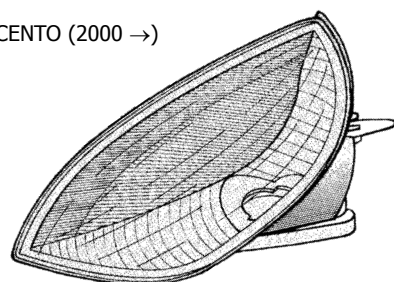

Versione speciale fumè
CRYSTAL-CLEAR
Smoked special version

P 7952 /D
/S

GOP: Seicento (1998 →)

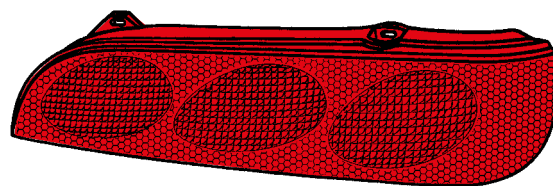

P 7953 /D
/S

GOP: Seicento (1998 →)

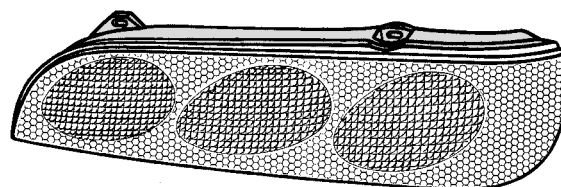

Versione speciale bianca
White special version

P 7954 /D
/S

GOP: Seicento (1998 →)

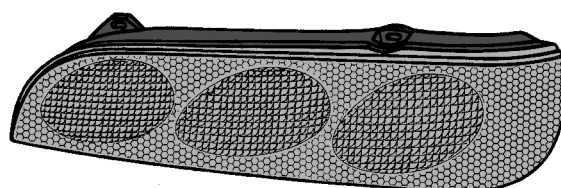

Versione speciale fumè
Smoked special version

P 7955 /D
/S

GOP: Seicento (1998 →)

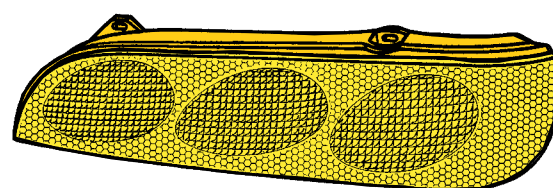

Versione speciale gialla
Yellow special version



P 7918 /S

GOP: Cinquecento (1992 → 98)



P 7919 /S

con portalampane
with bulbholder



P 7922 /S

GOP: Cinquecento Sporting - SX - SUITE (1995 → 98)



MTA: CARELLO

P 7920 /S

GOP: Cinquecento (1992 → 98)



Versione rossa/fumè
Red/smoked version

P 7923 /D
/S

GOP: Cinquecento (1992 → 98)

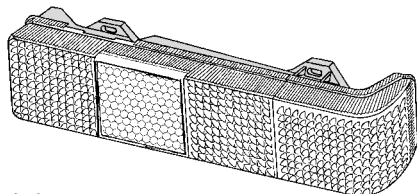

Versione speciale bianca
Clear special version

P 7924 /D
/S

GOP: Cinquecento (1992 → 98)

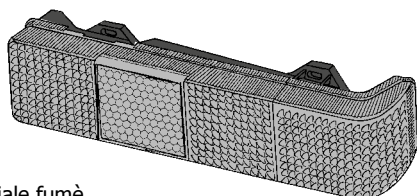

Versione speciale fumè
Smoked special version

P 7918 /D

GOP: Cinquecento (1992 → 98)

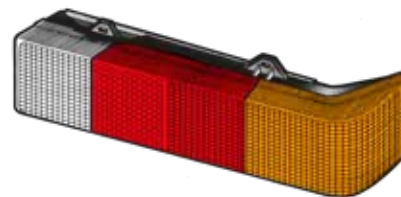

P 7919 /D

con portalampane
with bulbholder



P 7922 /D

GOP: Cinquecento Sporting - SX - SUITE (1995 → 98)



MTA: CARELLO

P 7920 /D

GOP: Cinquecento (1992 → 98)



Versione rossa/fumè
Red/smoked version

P 7925 /D
/S

GOP: Cinquecento (1992 → 98)

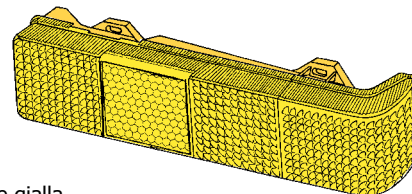

Versione speciale gialla
Yellow special version

P 7917

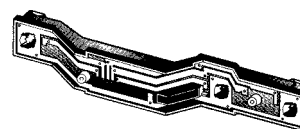

Piastra portalampane per ns/articoli
P 7918 - P 7920



P 8940 /S

GOP: GRANDE PUNTO (→ 2009)
Luce retronebbia

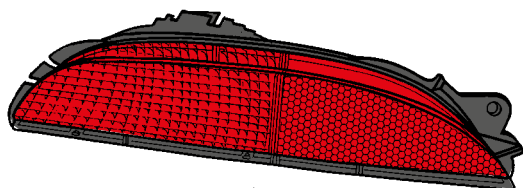

P 8942 /D
/S

GOP: GRANDE PUNTO (→ 2009)

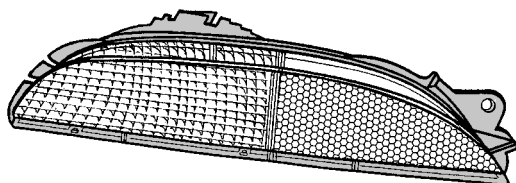

Versione speciale bianca
White special version

P 8944 /D
/S

GOP: GRANDE PUNTO (→ 2009)

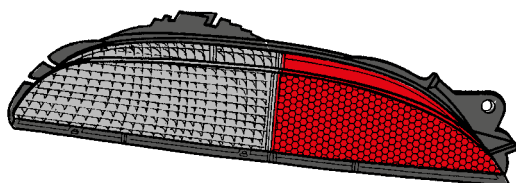

Versione speciale rossa/fumè
Red/smoked special version

P 8941 /D

GOP: GRANDE PUNTO (→ 2009)
Luce retromarcia

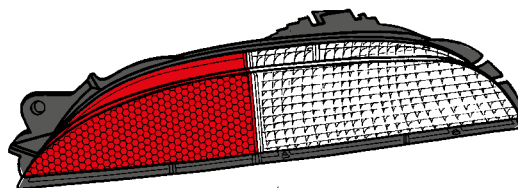

P 8943 /D
/S

GOP: GRANDE PUNTO (→ 2009)

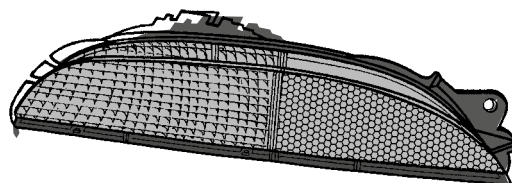

Versione speciale fumè
Smoked special version



P 8980 /D
/S

MTA: CARTO BRASIL

PFP: FIORINO (1991 →)
DUNA WEEK-END



P 8990 /D
/S

GOP: FIORINO (1991 →)
DUNA WEEK-END

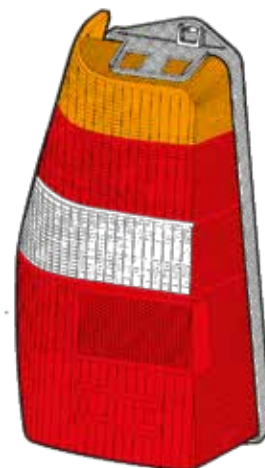

P 8680 /D
/S

MTA: VALEO - CIBIE'

P 8981 /D
/S

MTA: CARTO BRASIL

PFP: FIORINO (1991 →)
DUNA WEEK-END



P 8991 /D
/S

GOP: FIORINO (1991 →)
DUNA WEEK-END



P 8681 /D
/S

MTA: VALEO - CIBIE'



P 5389 /D
/S

PPF: UNIVERSALE RIMORCHI

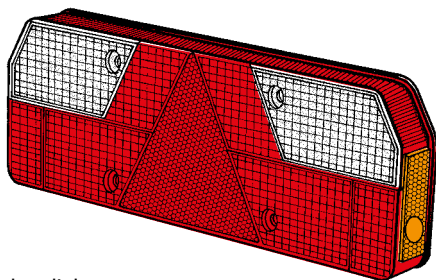

Senza luce targa
Without number plate light

P 5296 /D
/S

PPF: IVECO 190

MTA: SIEM

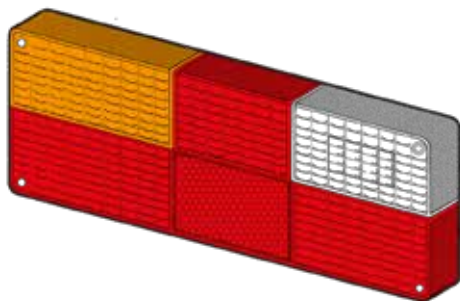

P 5289 /S

PPF: IVECO

MTA: COBO - OLSA - SIEM

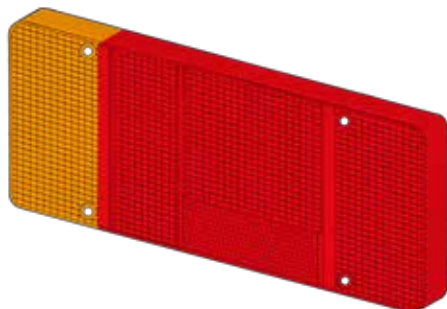

P 5290 /S

PPF: IVECO

MTA: COBO - OLSA - SIEM

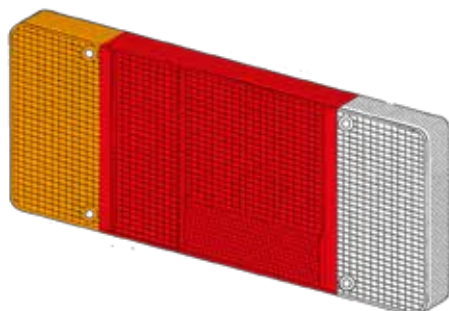

P 5489

PPF: IVECO DAILY (2006 →)

MTA: COBO

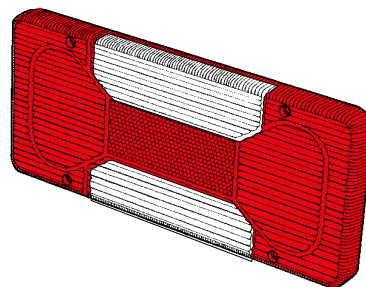

P 5376

PPF: IVECO NUOVO DAILY (1996 → 06)
GAMMA PESANTE (1994 → 06)

MTA: VALEO VIGNAL

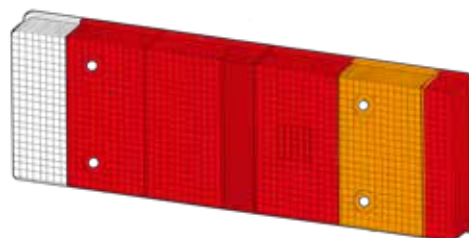

P 5289 /D

PPF: IVECO

MTA: COBO - OLSA - SIEM

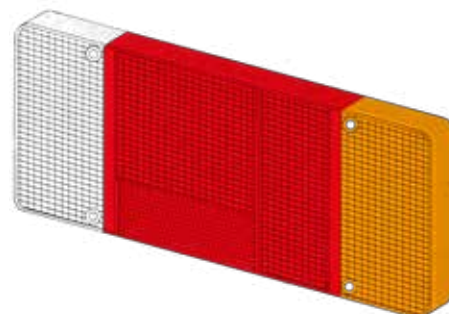

P 5290 /D

PPF: IVECO

MTA: COBO - OLSA - SIEM

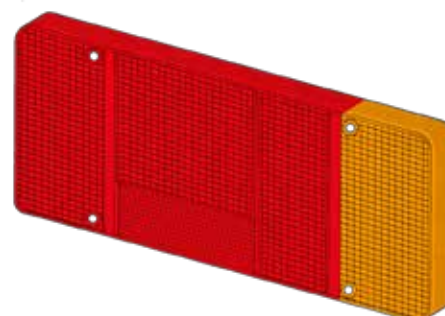

FIAT



FIAT

P 8978 /D
/S

PPF: UNO (→ 1989)

MTA: SIEM

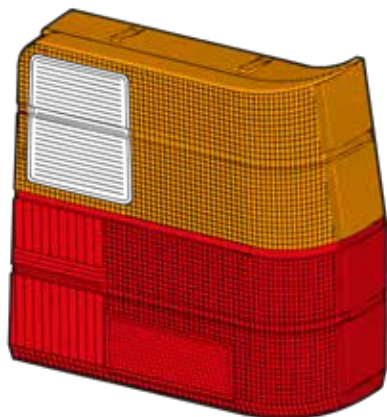

P 89781 /D
/S

PPF: UNO (→ 1989)

MTA: SIEM

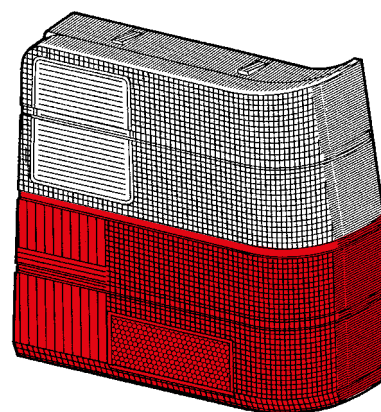

Versione speciale bianca/rossa
White/red special version

P 89782 /D
/S

PPF: UNO (→ 1989)

MTA: SIEM

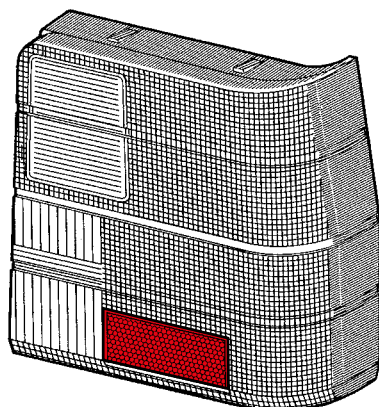

Versione speciale bianca
White special version

P 89783 /D
/S

PPF: UNO (→ 1989)

MTA: SIEM

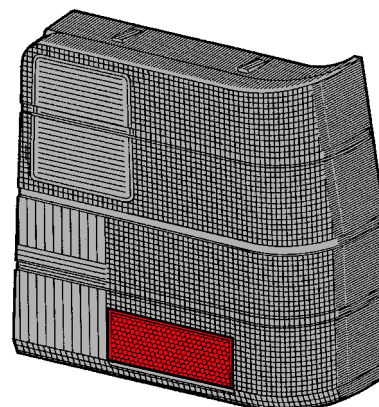

Versione speciale fumè
Smoked special version

P 8974

GOL: RITMO II Serie
UNO (→ 1989)
REGATA



P 89743

GOL: RITMO II Serie
UNO (→ 1989)
REGATA

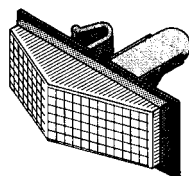

Versione speciale bianca
White special version

P 89744

GOL: RITMO II Serie
UNO (→ 1989)
REGATA

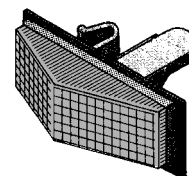

Versione speciale fumè
Smoked special version



CONDIZIONI GENERALI DI VENDITA

Questo catalogo contiene tutta la produzione P/V, con esclusione dei proiettori lampeggianti che sono presentati con altro apposito catalogo, elencata in ordine alfabetico della denominazione delle marche delle vetture alle quali vanno applicati i prodotti.

Alcuni articoli sono stati inclusi nel presente catalogo solo nella versione più richiesta o più consigliabile. Tuttavia è possibile che molti articoli, elencati nei precedenti cataloghi, siano disponibili a magazzino.

Tutti gli articoli elencati nel presente catalogo, pur essendo perfettamente intercambiabili agli originali, non sono originali. Tutti i riferimenti riportati in questo catalogo, sia di nomi di marche di vetture che di altri fabbricanti di ricambi, non attestano l'originalità, ma l'intercambiabilità dei prodotti. I prodotti riportati nel presente catalogo sono parti di ricambio di qualità equivalente, in conformità al Regolamento CE 1400/2002. I riferimenti al costruttore OEM sono offerti unicamente al fine di identificare l'utilizzo del ricambio.

La merce viaggia a spese, rischio e pericolo dell'acquirente, anche se resa franco destino.

Gli eventuali reclami per consegne difettose o incomplete devono essere fatti immediatamente all'atto del ricevimento della merce ed ogni eventuale resa di materiali dovrà essere da noi preventivamente autorizzata.

Gli eventuali difetti della merce, riconosciuti dal fornitore, obbligano lo stesso alla sola sostituzione del materiale alle medesime condizioni del contratto, con esclusione di ogni risarcimento per danni od altro.

Per qualsiasi controversia è in ogni caso competente il solo Foro di Milano.

This catalogue includes the entire P/V productions, except flashing lights which are shown in another catalogue, listed in alphabetical order following the domination of the car manufacturers.

Certain parts listed in the former catalogues and not contained in the present one may still be ordered, in any colour requested.

All items illustrated in this catalogue, although perfectly interchangeable with the original ones, are not original. All references made in this catalogue to individual brand names or other parts manufacturers, following the domination of the car manufacturers, do not claim to be original products, but are interchangeable products. Items listed in this catalogue are matching quality spare partes, in line with Regulation EC 1400/2002. References to OE manufacturers are provided solely for the purpose of identifying spare parts fitting.

Goods travel at customer's risk even when delivery term is free destination.

Any eventual claim on quantities or defects must be declared immediately on the receipt of the goods. Returned goods are accepted only if authorized in advance by us.

Should any lack be found on the goods delivered and acknowledged by the supplier, same is only bound to replace the goods in the same contractual terms, without any further refund of whatever additional charge for damns or other.

Should any dispute arise, the Court of Milano shall have the sole jurisdiction.

LEGENDA ABBREVIAZIONI

LIST OF ABBREVIATIONS

PFR:

Plastica per fanale retromarcia adattabile su
Reversing lamp lens adaptable for

PFP:

Plastica per fanale posteriore adattabile su
Rear lamp lens adaptable for

PFA:

Plastica per fanale anteriore adattabile su
Front lamp lens adaptable for

PFL:

Plastica per fanale laterale adattabile su
Side lamp lens adaptable for

GOP:

Gruppo ottico posteriore, senza portalamпада, adattabile su
Rear optical unit, without bulbholder, adaptable for

GOA:

Gruppo ottico anteriore, senza portalamпада, adattabile su
Front lamp optical unit, without bulbholder, adaptable for

GOL:

Gruppo ottico laterale, senza portalamпада, adattabile su
Side lamp optical unit, without bulbholder, adaptable for

FPC:

Fanale posteriore adattabile su
Rear lamp adaptable for

FAC:

Fanale anteriore adattabile su
Front lamp adaptable for

FLC:

Fanale laterale adattabile su
Side lamp adaptable for

CAT:

Catarifrangente
Reflex-reflector

GFA:

Guarnizione fanale anteriore adattabile su
Front lamp gasket adaptable for

GFP:

Guarnizione fanale posteriore adattabile su
Rear lamp gasket adaptable for

GFL:

Guarnizione fanale laterale adattabile su
Side lamp gasket adaptable for

CFP:

Corpo fanale posteriore adattabile su
Rear lamp body adaptable for

CFA:

Corpo fanale anteriore adattabile su
Front lamp body adaptable for

CFL:

Corpo fanale laterale adattabile su
Side lamp body adaptable for

MTA:

Modello tipo adattabile su fanale marca
Model suitable for individual type fitting